

Transient Voltage Suppressors Array for ESD Protection

SE05N9P11GJ

Features

- ◆ Ultra small package: 1.6x1.0x0.5mm.
- ◆ Protects one data or power line.
- ◆ Low clamping voltage.
- ◆ 2-pin leadless package.
- ◆ Complies with following standards:
 - IEC 61000-4-2 (ESD) immunity test
 - Air discharge: $\pm 30\text{kV}$
 - Contact discharge: $\pm 30\text{kV}$
 - IEC61000-4-5 (Lightning) 120A (8/20 μs)
- ◆ RoHS Compliant.

DFN1610-2L



Applications

- ◆ Mobile Phones.
- ◆ Battery Protection.
- ◆ Power Line Protection.
- ◆ Vbat pin for Mobile Devices.
- ◆ Hand Held Portable Applications.

PIN Configuration

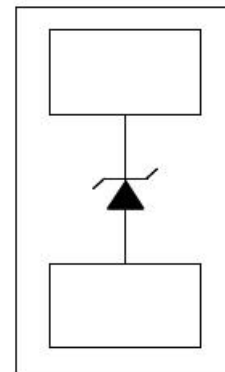

Mechanical Characteristics

- ◆ DFN1610-2L package
- ◆ Case Material: "Green" Molding Compound.
- ◆ Moisture Sensitivity: Level 1 per J-STD-020.

Absolute Maximum Rating ($T_A=25^\circ\text{C}$, unless otherwise specified)

Symbol	Parameter	Value	Units
I_{PP}	Peak Pulse Current (8/20 μs)	120	A
V_{ESD}	ESD per IEC 61000-4-2(Air)	± 30	KV
	ESD per IEC 61000-4-2 (Contact)	± 30	
T_{OP}	Operating Temperature Range	-55 to +125	$^\circ\text{C}$
T_{STG}	Storage Temperature Range	-55 to +150	$^\circ\text{C}$

Transient Voltage Suppressors Array for ESD Protection

SE05N9P11GJ

Electrical Characteristics (@ $T_A=25^\circ\text{C}$ unless otherwise specified)

Parameter	Symbol	Test Condition	Min	Typ	Max	Units
Reverse Working Voltage	V_{RWM}	--	--	--	5	V
Breakdown Voltage	V_{BR}	$I_T = 1\text{mA}$	5.8	--	--	V
Reverse Leakage Current	I_R	$V_{RWM}=5\text{V}$	--	--	1	μA
Clamping Voltage	V_C	$I_{PP}=10\text{A}$ (8/20 μs pulse)	--	7	--	V
		$I_{PP}=120\text{A}$ (8/20 μs pulse)	--	16	--	
Junction Capacitance	C_J	$V_R=0\text{V}$, $f=1\text{MHz}$	--	950	--	pF

Electrical Parameters ($T_A = 25^\circ\text{C}$ unless otherwise noted)

Symbol	Parameter
I_{PP}	Maximum Reverse Peak Pulse Current
V_C	Clamping Voltage @ I_{PP}
V_{RWM}	Working Peak Reverse Voltage
I_R	Maximum Reverse Leakage Current @ V_{RWM}
V_{BR}	Breakdown Voltage @ I_T
I_T	Test Current
I_F	Forward Current
V_F	Forward Voltage @ I_F

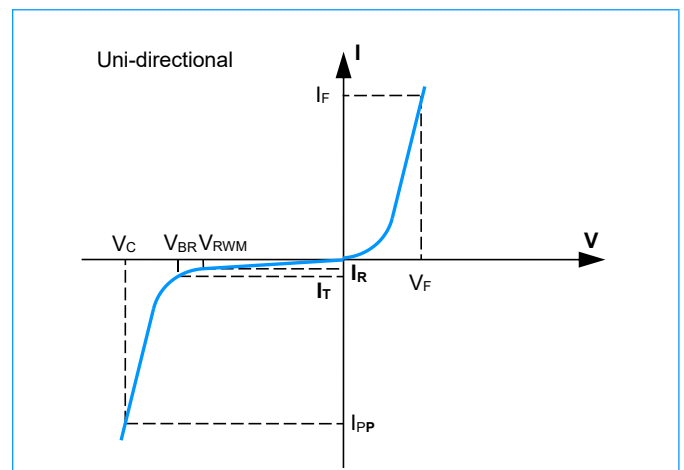

Typical Performance Characteristics ($T_A=25^\circ\text{C}$ unless otherwise specified)

Fig1. Junction Capacitance vs. Reverse Voltage

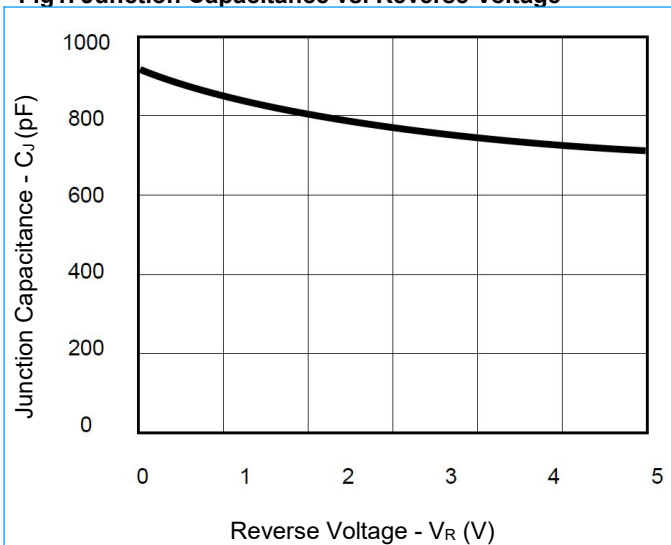
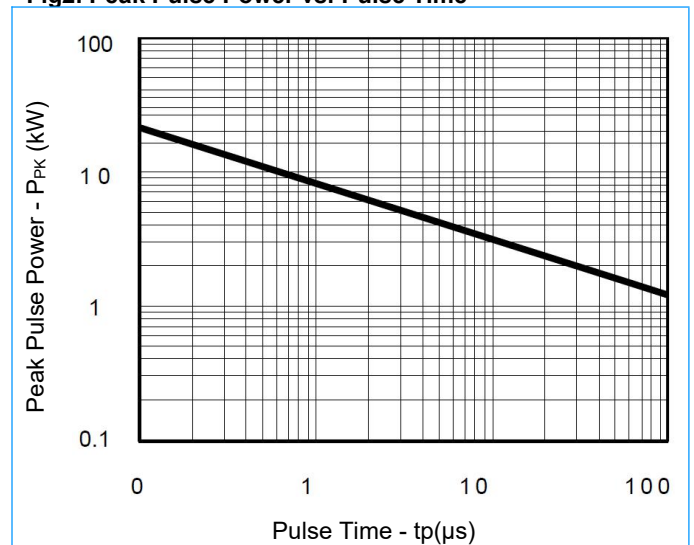

Fig2. Peak Pulse Power vs. Pulse Time



Transient Voltage Suppressors Array for ESD Protection

SE05N9P11GJ

Typical Performance Characteristics ($T_A=25^\circ\text{C}$ unless otherwise specified) (Continue)

Fig3. Clamping Voltage vs. Peak Pulse Current

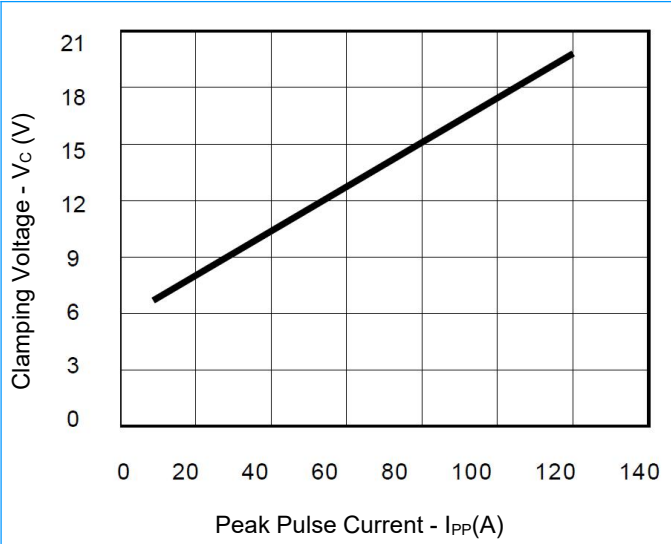

Fig4. Power Derating Curve

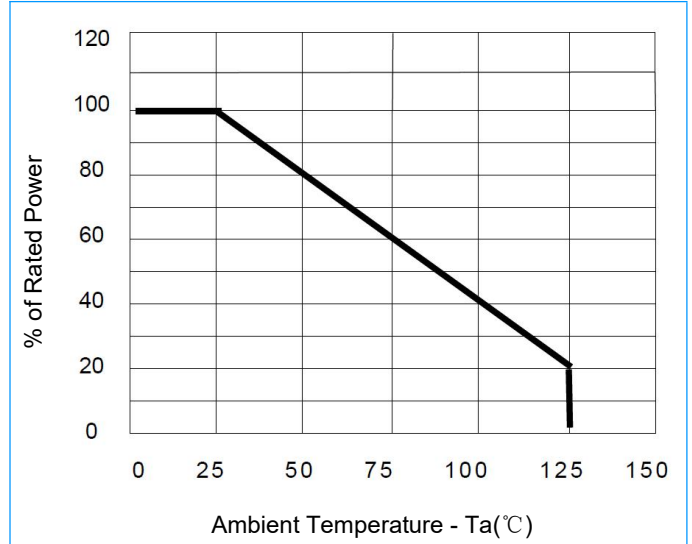
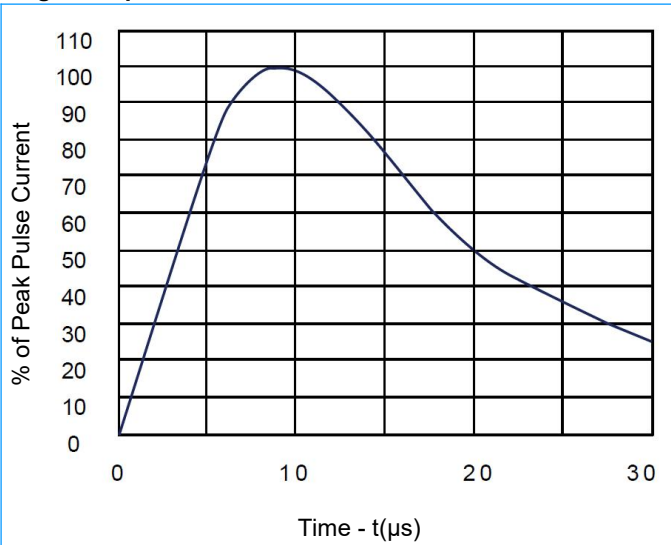

Fig5. 8/20 μs Pulse Waveform



Transient Voltage Suppressors Array for ESD Protection

SE05N9P11GJ

DFN1610-2L Package Outline Drawing

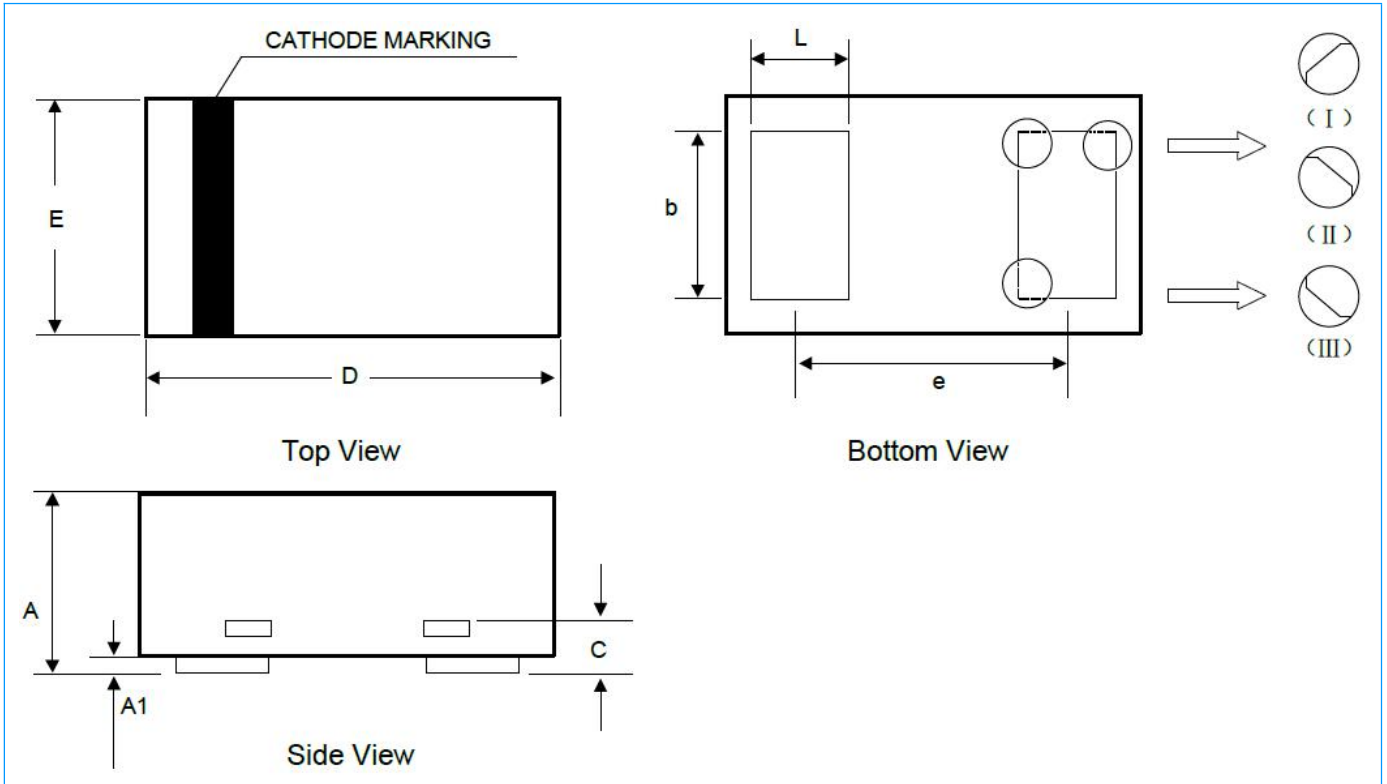

Symbol	Dimensions					
	Millimeters			Inches		
	Min.	Nom.	Max.	Min.	Nom.	Max.
A	0.45	0.50	0.55	0.018	0.020	0.022
A1	0.00	0.02	0.05	0.000	0.001	0.002
b	0.75	0.80	0.85	0.030	0.032	0.034
c	0.10	0.15	0.20	0.004	0.006	0.008
D	1.55	1.60	1.65	0.062	0.064	0.066
e	1.10 BSC			0.044 BSC		
E	0.95	1.00	1.05	0.038	0.040	0.042
L	0.35	0.40	0.45	0.014	0.016	0.018

Transient Voltage Suppressors Array for ESD Protection

SE05N9P11GJ

Packaging Quantity

Part Number	Packaging Option	Quantity
SE05N9P11GJ	Tape & Reel	3000 PCS

Warning



- ◆ SOCAY owns the rights to a number of patents, trademarks, copyrights, trade secrets, and other intellectual property.
- ◆ SOCAY reserves the right to make changes without further notice to any products herein.
- ◆ SOCAY makes no warranties, representations or warranties as to the fitness of its products for any particular purpose, and disclaims any liability.
- ◆ The parameters provided in the SOCAY datasheet specification may vary from application to application, and the actual performance may vary over time. All operating parameters must be verified by the customer's technical expert before application.
- ◆ Any and all responsibilities and liabilities are disclaimed if any item under this notice of warning is not complied with.